

8" ProBlock Split Face

square end

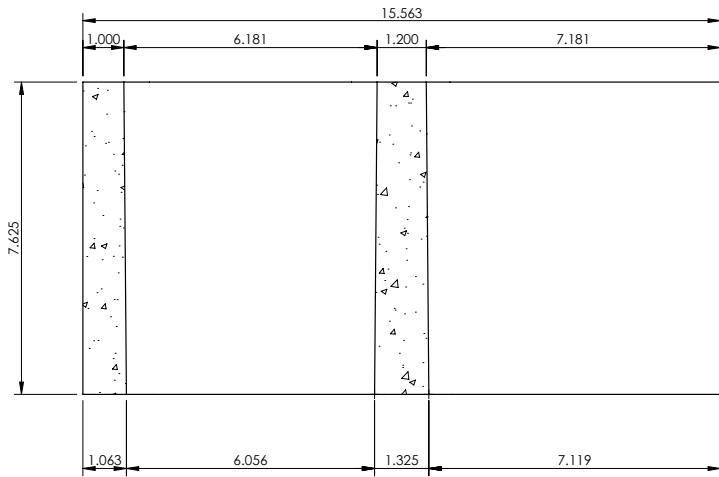

SECTION A-A

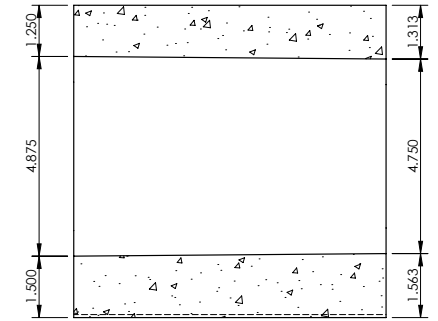
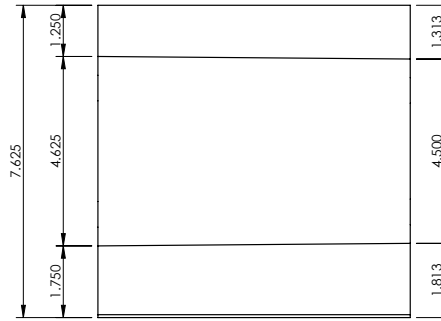
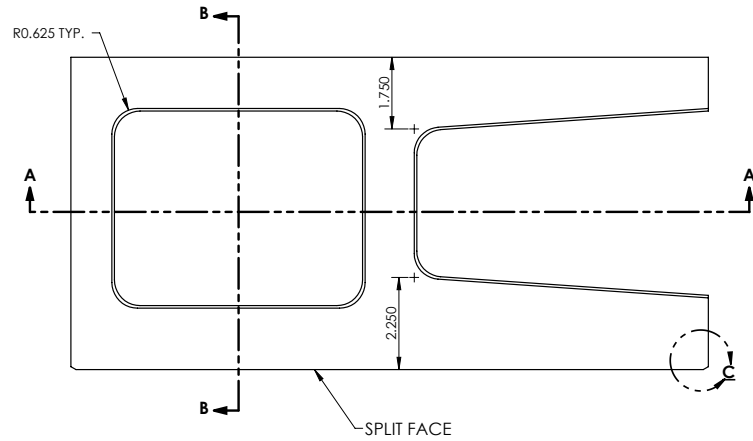
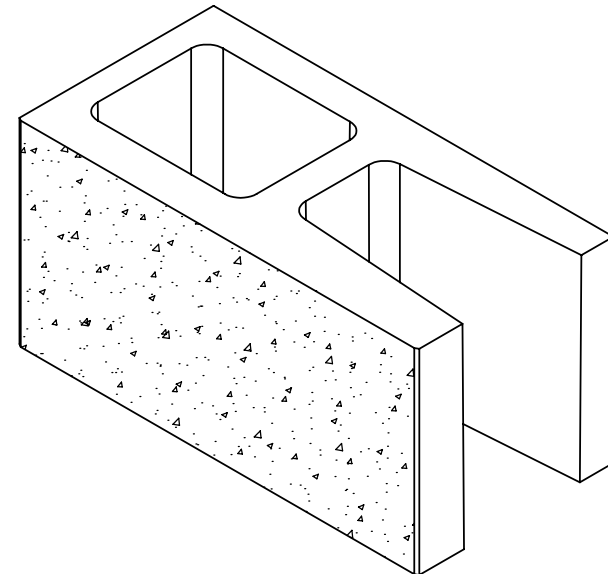
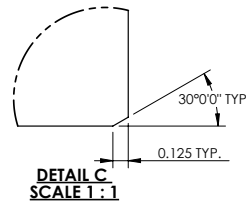

8" ProBlock Split Face

with sash

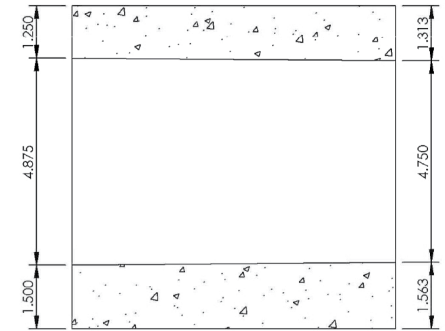
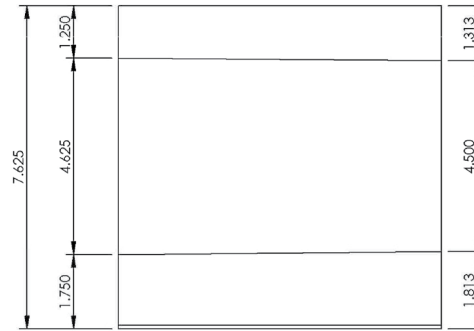
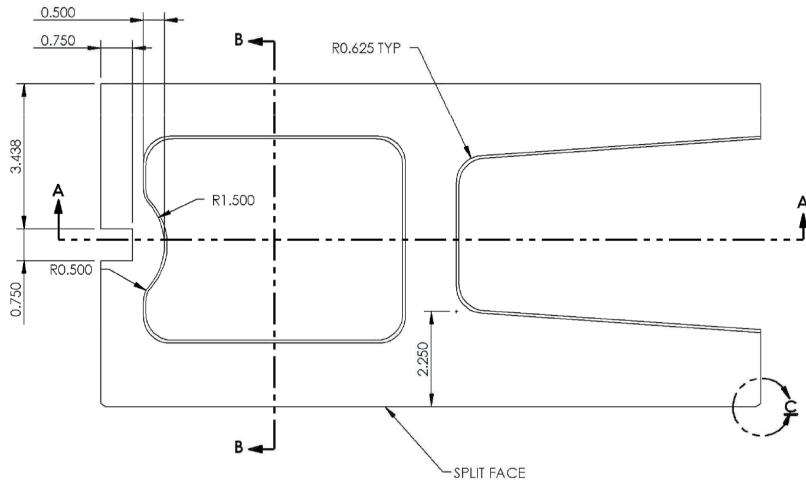

SECTION B-B

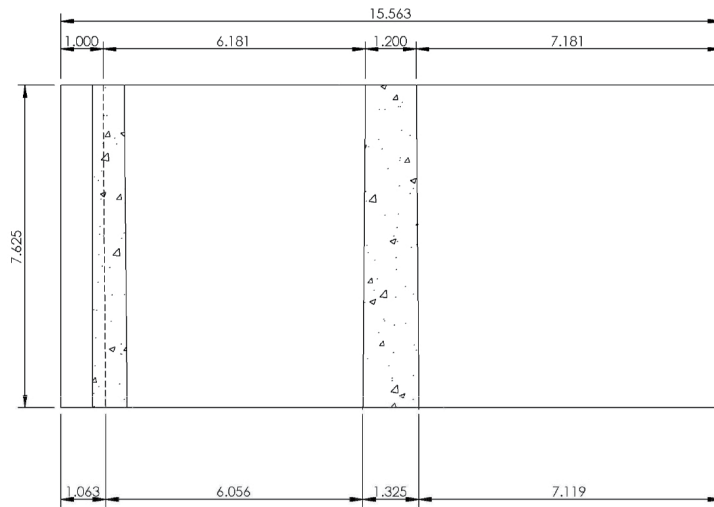
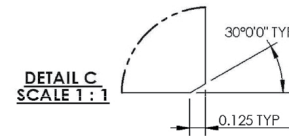

SECTION A-A

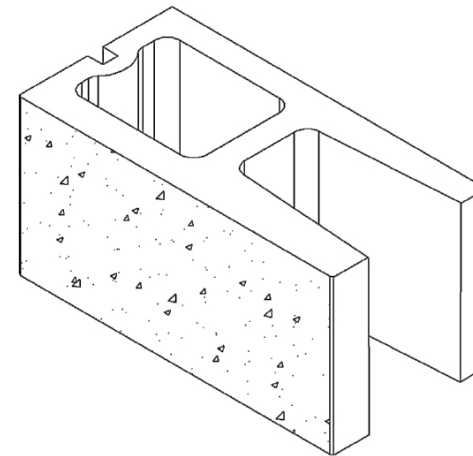

12" ProBlock Split Face

square end

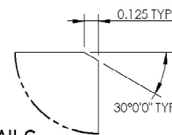
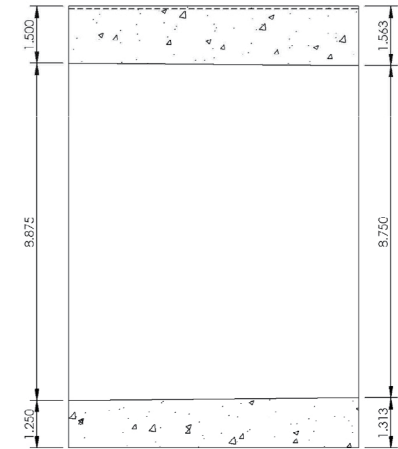
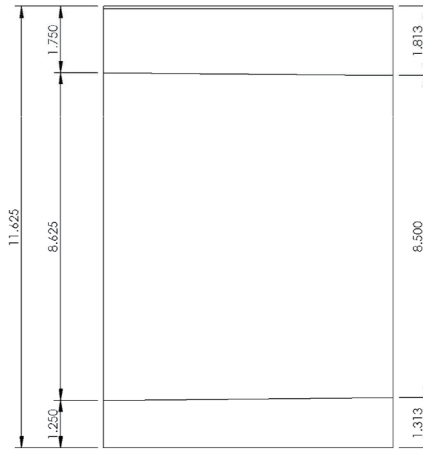
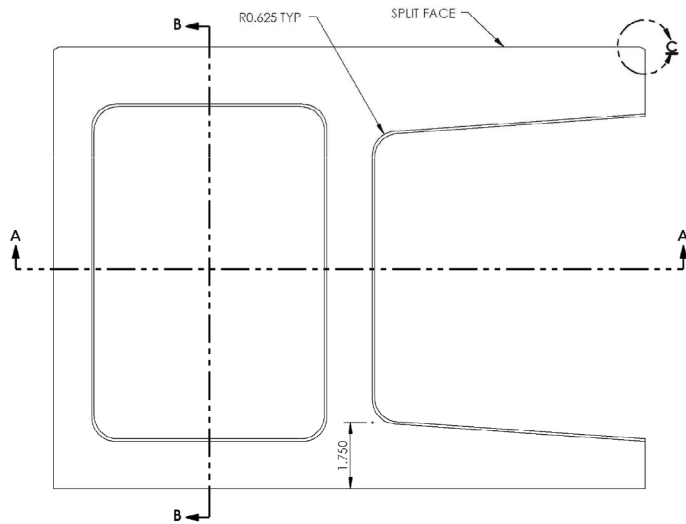

DETAIL C
SCALE 1 : 1

SECTION B-B

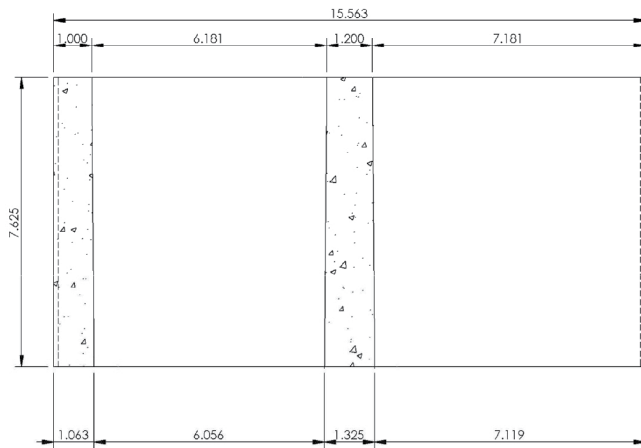

SECTION A-A

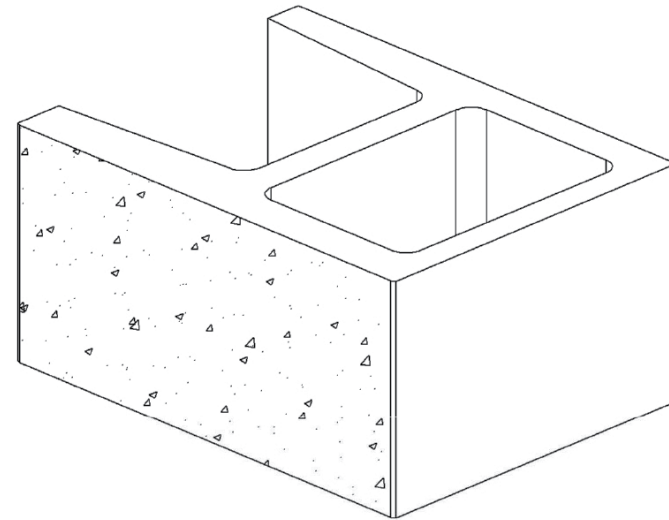

12" ProBlock Split Face

with sash

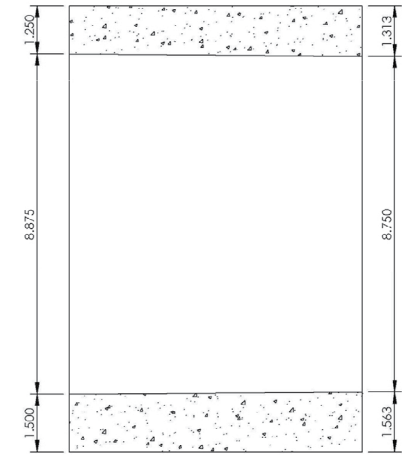
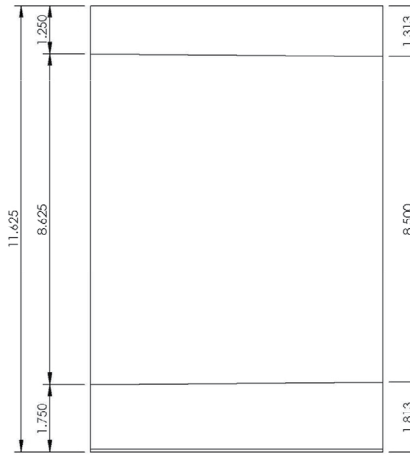
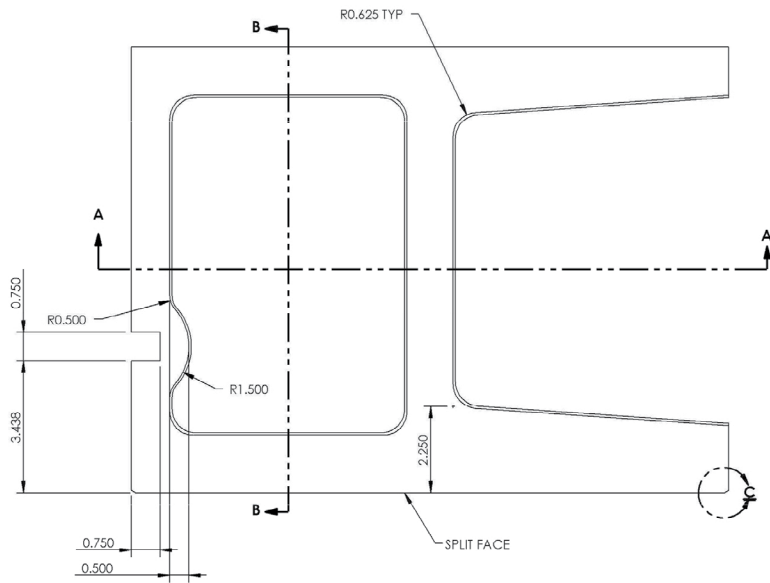

SECTION B-B

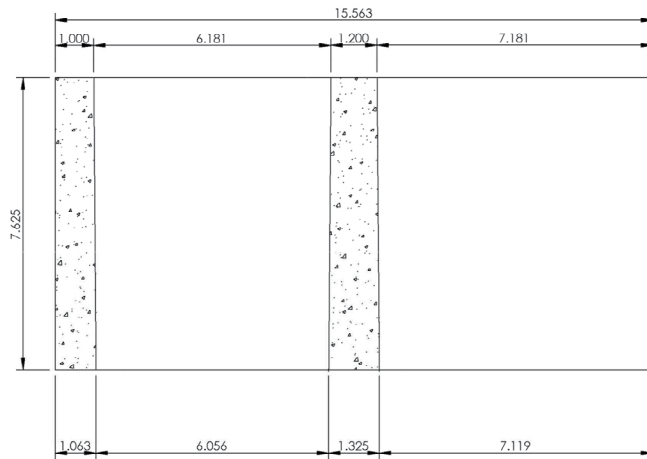
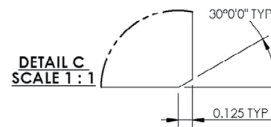

SECTION A-A

